



America's Oldest Stove Company
(Est. 1838)

JOB _____ ITEM # _____

72" WIDE RANGES

Base Model: 2F330, F33033



Model 2F330-1.5RB-30B
(shown w/ low back* & optional casters)

Standard Features, Benefits & Options

OVENS: 31.5" w x 22" d x 14" h for superior baking characteristics and results. Heavy insulation for fuel efficiency. Easy cleaning porcelain and aluminized linings with one nickel plated rack. 3 rack positions with 2¾" between rack positions. Long life, 30,000 BTU cast iron "H" pattern oven burner combined with special "V" shaped baffle directs heat for excellent air circulation.

COOK TOPS: 24,000 BTU "star" pattern top burners with no gaskets to leak. The large 7" flame spread offers a more efficient burn pattern for small to large pots. Full width crumb trays catch all spillage. Top grates are 12" x 12" cast iron with spillover bowl that also reflects heat for added efficiency. Designed for easy movement of pots across top sections. Stainless steel bullnose-rail is safely flush with the cook tops and functional to straddle pots, skillets and plates and also serves as control protection.

CONSTRUCTION: Easy cleaning, corrosion resistant stainless steel finish, welded with angle iron and aluminized inner framing. Sturdy 6" heavy duty stainless pipe legs with adjustable feet. Double wall construction with heavy insulation for cooler operation. Installation clearances for non-combustible surfaces are 0" on sides and 0" in the rear, combustible surface clearances are 2" and 2".

CONTROLS: Includes 500° thermostat, 100% safety shut off, automatic standing pilot and brass top burner valves. Pressure regulators are set at the factory for the gas specified. Optimal pressures are 4" WC for natural gas and 10" WC for propane. Manifold size is ¾" NPT. All controls are tested and confirmed in good working order. Calibration and adjustments are the responsibility of the buyer.

GRIDDLES: 12" increments have 20,000 BTU cast iron burners replacing front to back open burner pairs. 18" & 30" sections feature 2 & 4 "I" burners respectively, rated at 18,000 BTU each, available only when matched together with 18" or 30" char-broilers. ¾" thick is standard. SS splash guards tapering to 4". Front grease trough and large capacity grease catch. Optional raised griddle-cheesemelters with rear trough are available up to 36". Maximum rack clearance is 4½".

CHAR-BROILERS: 12" increments have 25,000 BTU cast iron burners replacing front to back open burner pairs. 18" & 30" sections feature 2 & 4 "T" burners respectively, rated at 20,000 BTU each, available only when matched together with 18" or 30" griddles. Flare up reducing cast iron top grates and radiants for superior heat retention. Front grease trough and large capacity grease catch. SS splash guards tapering to 4". Char-broilers are approved for use in non-combustible locations only.

HOT TOPS: Available in 12" width increments in lieu of open top burners. ¾" thick to hold heat from long life, even heating 20,000 BTU cast iron "H" pattern burners.

ACCESSORIES & OPTIONS: Casters, extra racks, pizza decks, FD oven thermostats, oven spark pilots, chrome griddle plates, 1" thick griddle plates, griddle thermostats, safety pilot griddles, lift off griddles, grill scrapers, cleaning supplies, hose and quick disconnects, control protection bars, storage base in lieu of oven and low backs are some of the standard options and accessories available.



Comstock-Castle Stove Co. • 119 W. Washington St. • Quincy, IL. 62301
Tel.: 217-223-5070 • Fax: 217-223-0007 • www.castlestove.com



72" RANGES MEASUREMENTS

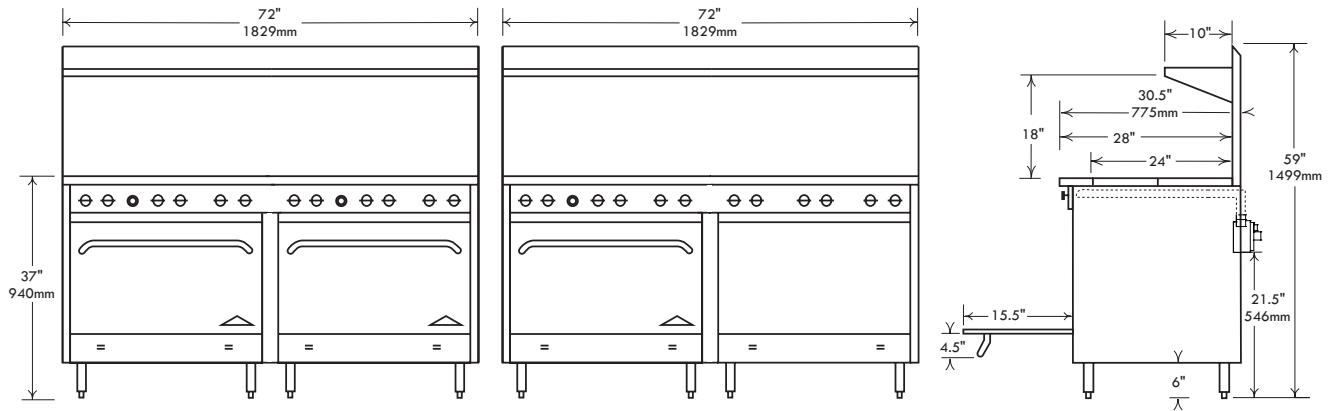

72" Ranges (Popular models shown below. Call factory for other model details.)

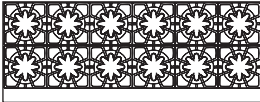
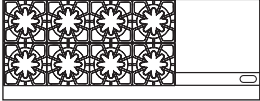
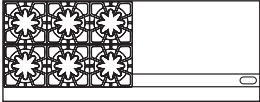
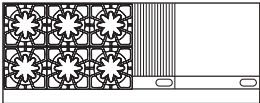
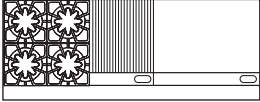
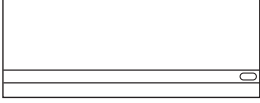
Cooktop Configuration	Model #	Description		Total B.T.U.	Approx. Wgt. Kg. / Lbs.
		Top	Base		
	2F330 F33033	(12) Open Burners	- w/ (2) 31.5" Ovens	348,000	432 / 950
		(12) Open Burners	- w/ (1) 31.5Oven - & 34" storage space	318,000	383 / 840
	2F330-24	(8) Open Burners	- w/ (2) 31.5" Ovens	292,000	468 / 1032
	F33033-24	& (1) 24" Griddle	- w/ (1) 31.5" Oven	262,000	418 / 920
	2F330-24B	(8) Open Burners	- & 34" storage space - w/ (2) 31.5" Ovens	282,000	491 / 1080
		& (1) 24" Griddle, 1" cheesemelter			
	2F330-36	(6) Open Burners	- w/ (2) 31.5" Ovens	264,000	500 / 1100
		& (1) 36" Griddle			
	F33033-36	(6) Open Burners	- w/ (1) 31.5" Oven	234,000	450 / 990
	2F330-36B*	& (1) 36" Griddle	- & 34" storage space	264,000	523 / 1150
		(6) Open Burners	- w/ (2) 31.5" Ovens	264,000	523 / 1150
		& (1) 36" Griddle, 30" cheesemelter			
	F33033-36B*	(6) Open Burners	- w/ (1) 31.5" Ovens	234,000	473 / 1040
		& (1) 36" Griddle, 30" cheesemelter	- & 34" storage space		
*not ETL design listed					
	2F330-24-1RB	(6) Open Burners	- w/ (2) 31.5" Ovens	269,000	536 / 1180
		& (1) 24" Griddle			
		& (1) 12" Radiant Broiler			
	2F330-30-1.5RB	(4) Open Burners	- w/ (2) 31.5" Ovens	268,000	532 / 1170
		& (1) 30" Griddle			
		& (1) 18" Radiant Broiler			
	2F330-1.5RB-30B*	(4) Open Burners	- w/ (2) 31.5" Ovens	216,000	536 / 1180
		& (1) 18" Radiant Broiler			
		& (1) 30" Griddle, 24" cheesemelter			
*not ETL design listed					
	2F330-72	(0) Open Burners	- w/ (2) 31.5" Ovens	180,000	555 / 1220
		& (1) 72" Griddle			
	F33033-72	(0) Open Burners	- w/ (1) 31.5" Oven	150,000	505 / 1110
		& (1) 72" Griddle	- & 34" storage space		

Note: Radiant char-broiler sections and hot top available, add suffix -1RB, -2RB or -1HT, -2HT, etc. per section.

Top sections in lieu of open top burners are located on the right when viewing from the front. Special locations may require custom work and pricing, please call for details.

Gas connection location as you look from the front: 21" from the floor, 3" from the left side.

NOTICE: In an ongoing effort of product development & improvement, Comstock-Castle reserves the right to change specifications and product design without notice. Such modifications do not entitle the buyer to corresponding changes or replacements for previously purchased equipment.

